

N'hésitez pas de nous contacter si vous avez des questions au sujet de cette gamme de produits.

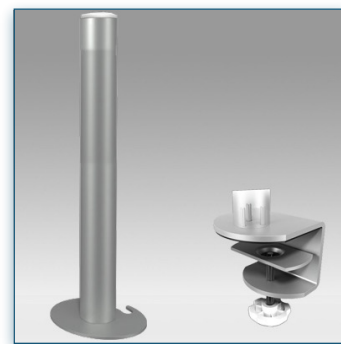

Garantie: 5 ans



000.152.9882



Gris Métallisé



800 x 75 x 75 mm



1,3 Kg



152.9882